

A

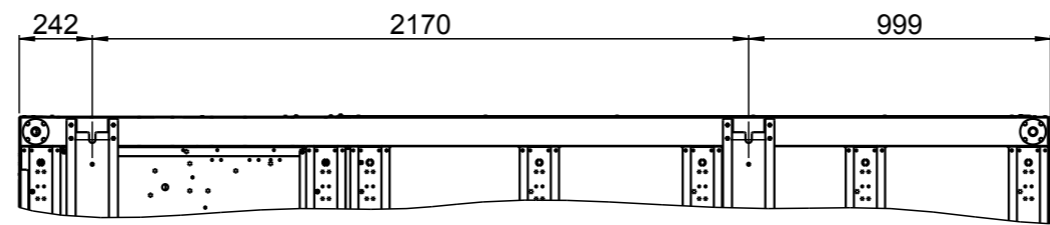

A

B

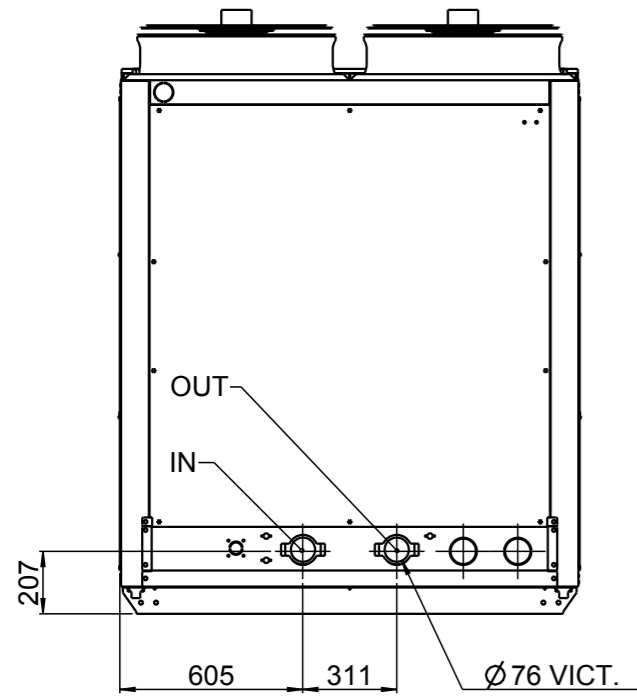

B

C

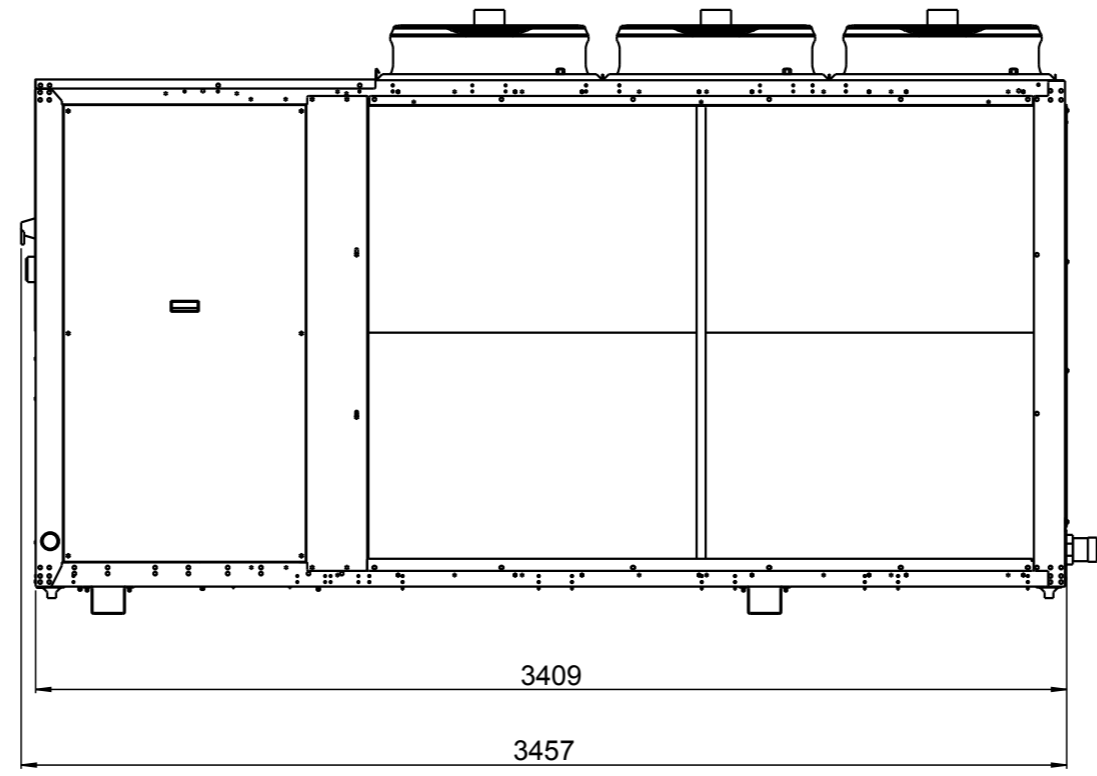

C

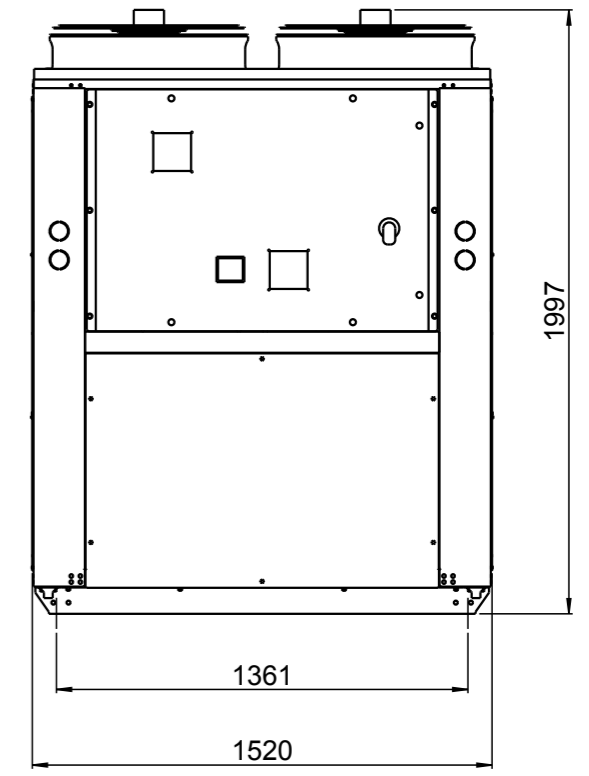

D

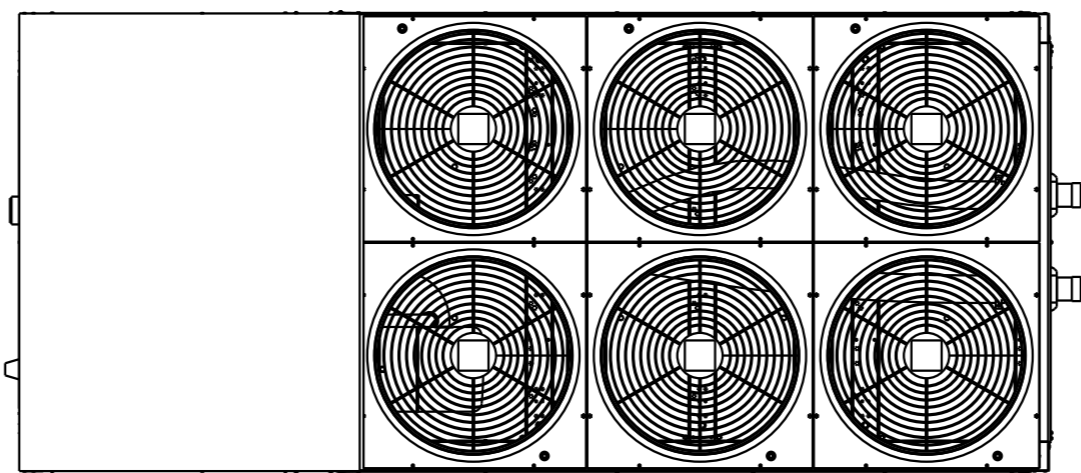

D

E

E

F

F

-				NUOVA EMISSIONE		08/03/2016	MORETTO	ALBIERI
REV.	SCALA	FORM.	FOGLIO	DESCRIZIONE	NOME MODELLO	DATA	FIRMA	CONTROLLO
	1:25	A3	1/1	STATO DISEGNO				
MATERIALE					SPESORE			
FINITURA				SPECIFICA COSTRUTTIVA	GAMMA			
					EASYPACK			
DESCRIZIONE						N° DISEGNO	REV.	
MAC THAETY 2146 B P EASYPACK						5000093		
IL PRESENTE DISEGNO E' DI PROPRIETA' DELLA DITTA Rhoss s.p.a. LA RIPRODUZIONE, ANCHE PARZIALE, E' VIETATA SECONDO LE NORME VIGENTI								